

LEVEL UP - CERAMIC



INDEX

1. Code Registry
2. Use
3. Load Tests
4. Technical Specification

1. CODE REGISTRY

| Product Code | Description | Material | Measure (mm) | Weight | Colour | Pkg. / Pallet |
|--------------|---|--------------------|----------------------|-------------|------------|---------------------|
| TER09-1125 | Laying Module | PP (polypropylene) | 600 x 600 | 2,60 kg/pc. | Black | 1 pc. / 30 pc.* |
| POZ95-1313 | Reinforcement profile | Galvanized Steel | 482 | 0,28 kg/pc. | Galvanized | 30 pc. / - pc.* |
| TER09-1126KT | Support base+ Support adjustment + Fixing support | PP (polypropylene) | from 48 to 74 | 7,60 kg/pc. | Black | 38 pc. / 570 pc.* |
| TER09-1130 | Extension h.25 mm | PP (polypropylene) | h. 25 | 0,09 kg/pc. | Black | 38 pc. / 1520 pc.* |
| TER09-1129 | Extension h.50 mm | PP (polypropylene) | h. 50 | 0,14 kg/pc. | Black | 38 pc. / 760 pz*. |
| TER09-1133 | Fixed Connector | PP (polypropylene) | ø 123 - h. 40 | 0,2 kg/pc. | Black | 100 pc. / 3.000 pc. |
| TER09-1144 | Sound absorbing mat | Rubber (TPV) | 200 x 200 - thick. 3 | 0,09 kg/pc. | Black | 80 pc. / 6.720 pc. |

*Product's quantities on each packaging are defined to cover an area of 5.4 m²

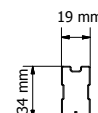
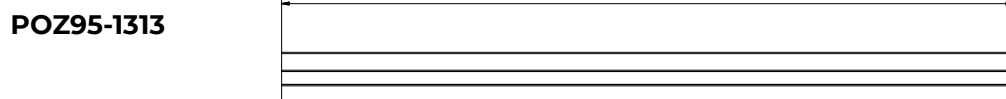
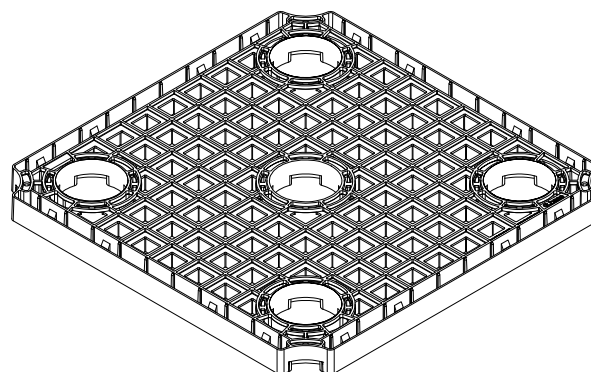
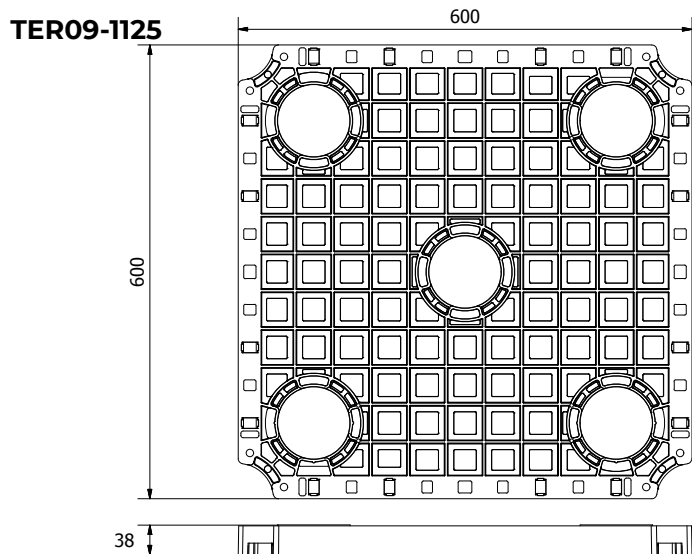

LEVEL UP - CERAMIC

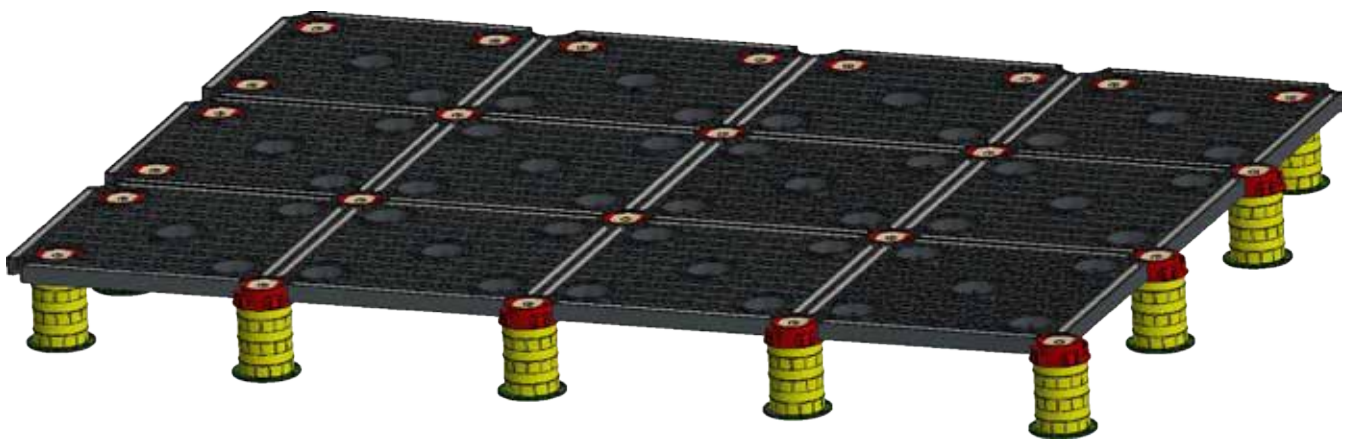
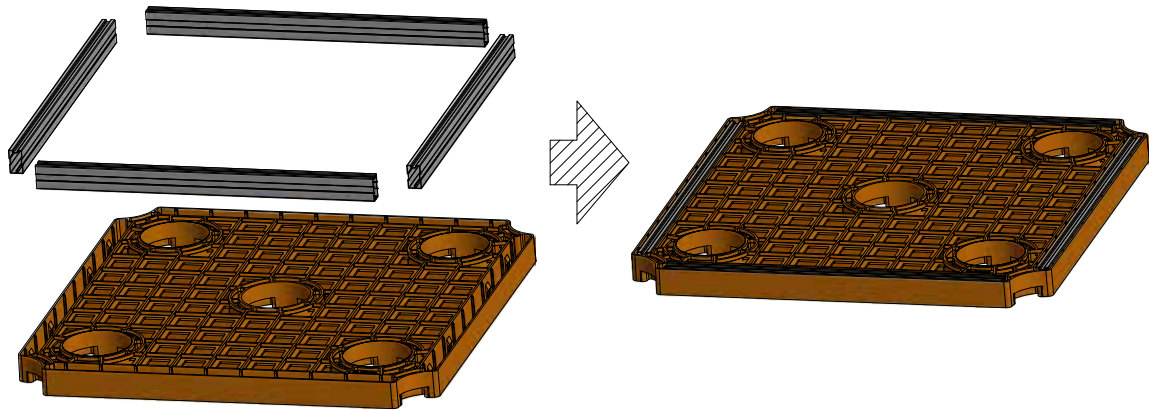
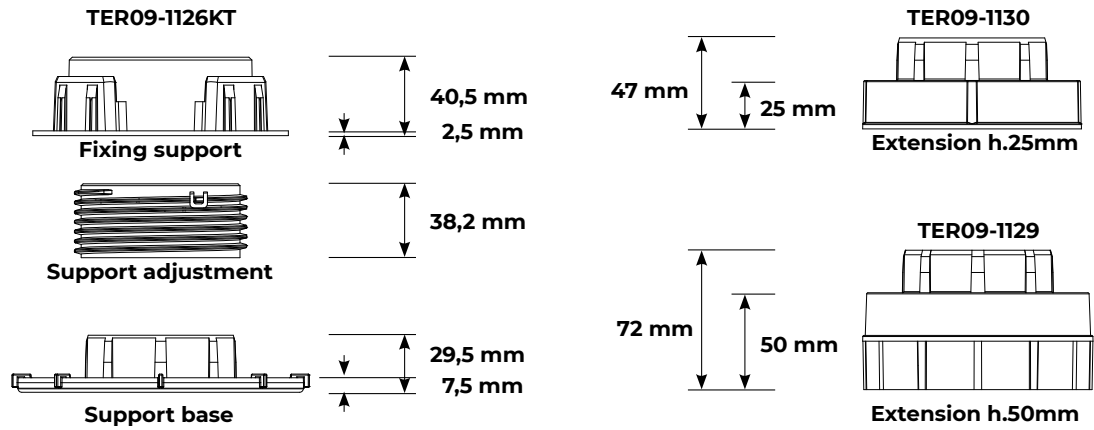





LEVEL UP - CERAMIC

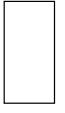

2. USE

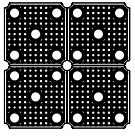
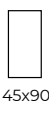
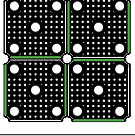
Modular structure for the laying of floating floors for outdoor use.

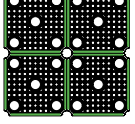
The system is specifically designed for the installation of tiles of various thicknesses and sizes, both with simple laying and with a stretcher bond pattern.

| SIZES | STRINGERS NUMBER | |
|--|--|---|
|  90x90  90x120  60x60 | NO ELEMENTS CONTEMPLATED |  |
|  45x90 | 2 REINFORCEMENT PROFILES (LAID IN ALTERNATE PAIRS) |  |
|  40x120  30x120 | 4 REINFORCEMENT PROFILES (COMPLETE LAYING) |  |

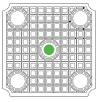
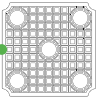
3. LOAD TESTS

| BREAKAGE LOAD* | | 1 daN = 1 Kg |
|------------------|---|--------------------------|
| PUNCTUAL LOAD | MIDDLE OF THE PANEL  | > 900 daN |
| | MIDDLE OF THE SIDE  | > 700 daN |
| | DIAGONAL LINE  | > 900 daN |
| | MAX WORKING LOAD EN 12825 SAFETY FACTOR=2 | 375 daN |
| DISTRIBUTED LOAD | MAX DISTRIBUTED LOAD. | 1.875 daN/m ² |

*Load test are made with 4 reinforcement profiles installed on each laying module.

4. TECHNICAL SPECIFICATION

| Specification | Description | Unit |
|---------------------------|---|------|
| Dak.O.TER09.1125 | Modular structure system for the laying of floating floors. The system is specifically designed for the use of tiles of various thicknesses and sizes, both with simple laying and with an stretcher bond pattern. Designed and reinforced to be durable and functional. Available in black colour. System made of PP (polypropylene). Dimensions 600 x 600 mm..... | |
| Dak.O.POZ95.1313 | Reinforcement profile, made of galvanized steel. Dimension: length 482 mm, Thickness 19 mm, height 34 mm | pc. |
| Dak.O.TER09.1126KT | Raising system for Level Up laying module, for height from 48 to 74 mm..... | pc. |
| Dak.O.TER09.1130 | Extension made of PP, h.25 mm..... | pc. |
| Dak.O.TER09.1129 | Extension made of PP, h.50 mm..... | pc. |
| Dak.O.TER09.1133 | Fixed support made of PP, ø123 - h. 40 mm..... | pc. |
| Dak.O.TER09.1144 | Sound absorbing mat made of TPV Rubber, 200 x 200 - spess. 3 mm..... | pz. |